



Installation Guide

Smart Link Series

10K Smart Link

Package Contents



Signal Booster



Outside Antenna



Outdoor Cable
32.8ft NM-SMAM



Outdoor Cable
16.4ft SMAF-NM



Indoor Antenna



Indoor Cable
30ft NM-NM



Power Supply

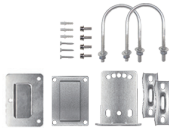

Accessories for main parts
are all provided



waterproof tape
to protect connections



Through-Window Cable
SMA-Male to SMA-Female
(No drilled hole)



Bluetooth and
Wi-Fi antenna

Booster Light Patterns

LED STATUS INDICATORS		
LED	STATUS	INDICATION
ALARM	Solid Green	Normal
	Slow Flashing Green	Slight Overload
	Quick Flashing Green	Overload
	Quick Flashing Red	Booster automatically shut off due to strong overload
Power LED	Green	Normal
	Off	DC Power Problem
ISO	Solid Green	Normal
	Slow Flashing Green	Slight Loopback
	Quick Flashing Green	Loopback
	Quick Flashing Red	Booster automatically shut off due to strong loopback

Note: If the booster automatically shut off, please manually reboot it.

LED STATUS INDICATORS		
LED	STATUS	INDICATION
Bluetooth	Slow Flashing Green	Bluetooth Disconnected
	Quick Flashing Green	Bluetooth Connected
Wi-Fi	Solid Green	Wi-Fi Disconnected
	Slow Flashing Green	Wi-Fi Connected

Bands contained in the Gauges on Signal Supervisor

Gauge	Band	Uplink	Downlink
LTE700	12/17	698-716MHz	728-746MHz
	13	776-787MHz	746-757MHz
CELL800	5	824-849MHz	869-894MHz
PCS1900	25/2	1850-1915MHz	1930-1995MHz
AWS2100	4	1710-1755MHz	2110-2155MHz

Please focus on the gauge that contains the band you are using.

Getting Started



Step 1 *Connect the Power Supply and the whip antenna to the Booster*



Step 2 *Download the Signal Supervisor App, register ID and booster.*

Register an ID first and log in.
Add the booster to the device list.

Step 3 Find the cell tower & Determine the outdoor antenna's position

3.1 Find the band you are using

For Android

Download NetWork Cell Info Lite in the Google store and open it.

It can be seen from the example picture that the frequency band is band 13. (According to the form before, you need to pay attention to Gauge LTE700)

Then click MAP. You can see your phone connecting to a tower, and you can try aiming your outdoor antenna at it. But sometimes this is not accurate. You could also move to Step 3.2 to find the tower

Note: Please take screenshots at this stage.



For ios

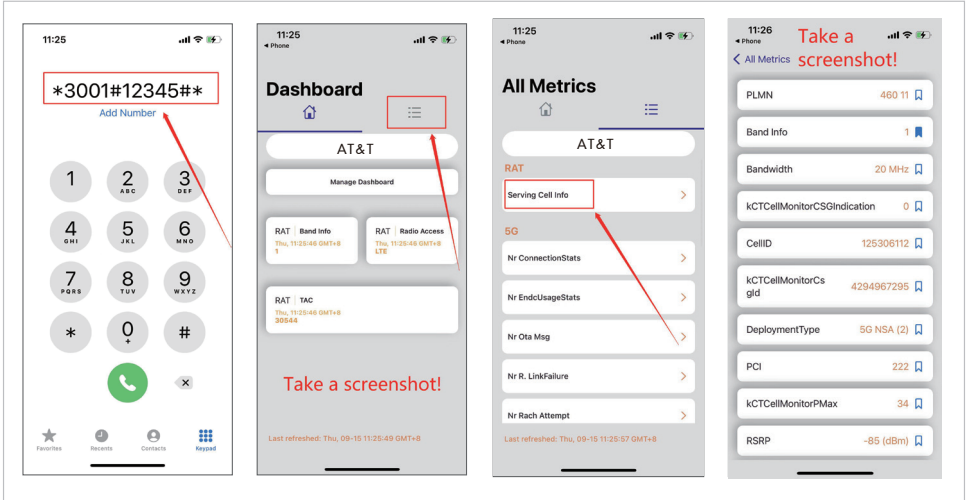

- (1) Dial `*3001#12345#*`
- (2) Follow the instructions, take the screenshots as required.

3.2 Find the cell tower

- (1) Enter `cellmapper.net`
- (2) Choose your own carrier and band here.

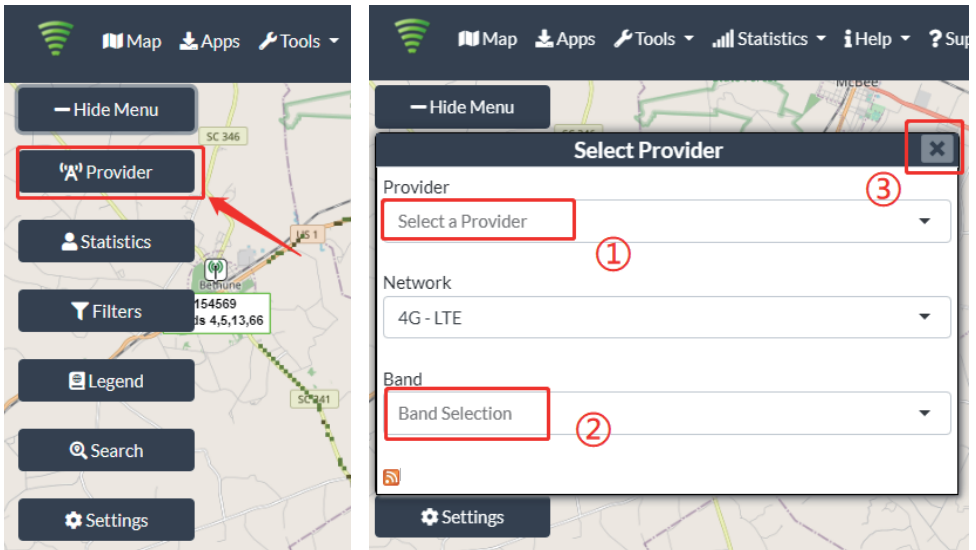

(3) Then enter the coordinate of where you are trying to install the signal booster, and press Enter key.

(In fact when you open Cellmapper, the map on the right will automatically locate your area if you've given the site permission to access your location. If you found tower sites not even displayed on the map, it might be because the app intercepts the locations for security reasons.)

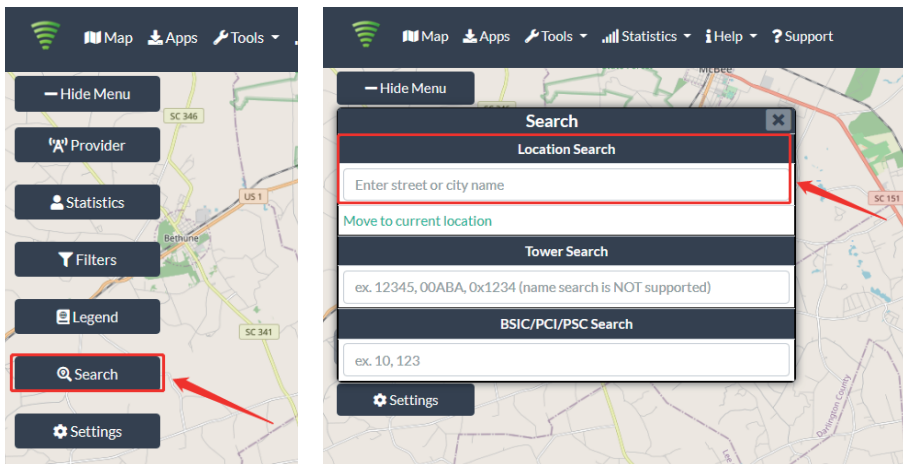

(4) After the map jumps to the location, you can scroll the mouse pulley and zoom it out, then you will see the tower near the location. It would be better to take a screenshot of this page to guide the following installing steps. Should you have any questions, please contact our tech support.

Note: If you need help finding the tower, please contact our tech support and provide your carrier, band and screenshots taken in the last steps.

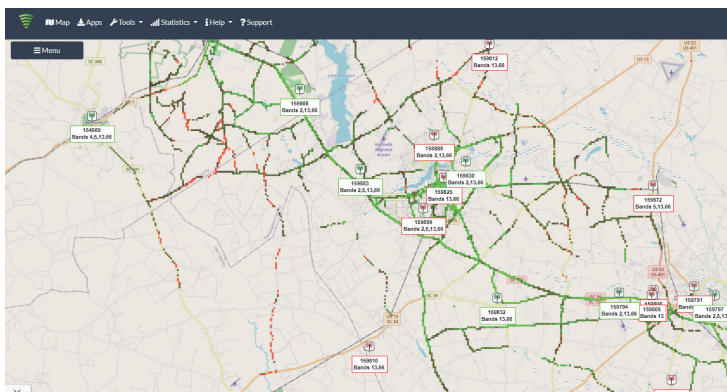

3.3 Determine the outdoor antenna' s position

The outdoor antenna is usually placed at one of the 4 ends of the roof.

Please choose the position according to the tower' s location. Make sure there are no barriers between the antenna and the tower.

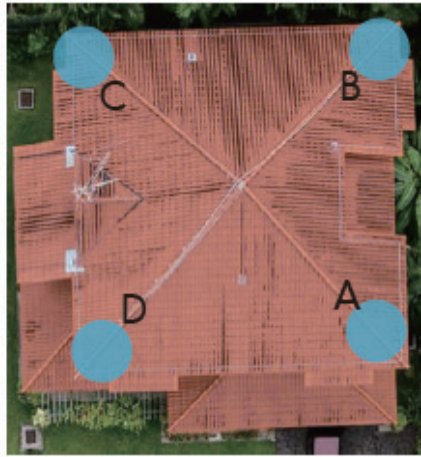

Step 4 Connect the outdoor antenna with the booster

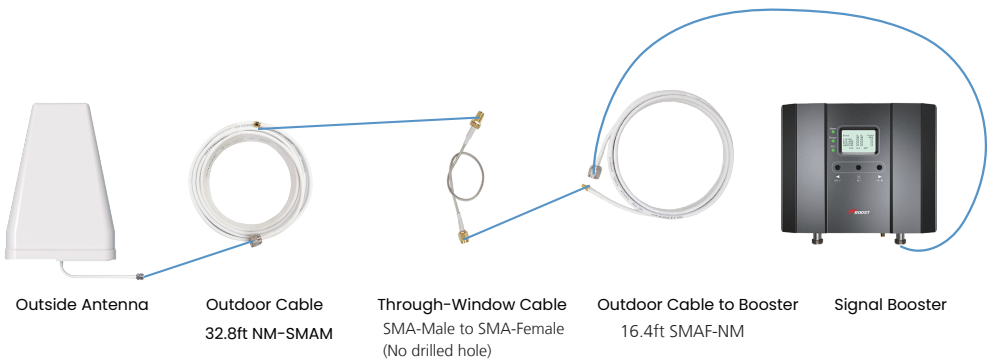

Note: At this stage, don' t connect the indoor antenna to the booster.

Step 5 Adjust and fix the Outdoor Antenna

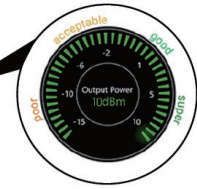
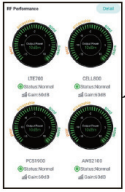

Have your outdoor antenna pointed to the cell tower you found before and observe the reading on the app. Adjust the outdoor antenna accordingly.

Notes:

- (1) The output power should be the higher the better.
- (2) The full output power for 10k Smartlink is 12dBm. And the full gain is 65dB.

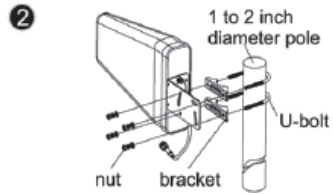
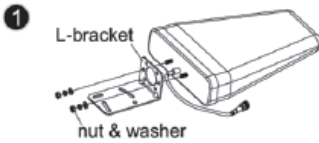

Step 6 Connect the indoor antenna with the booster



Step 7 Adjust the indoor antenna

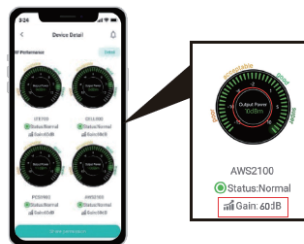
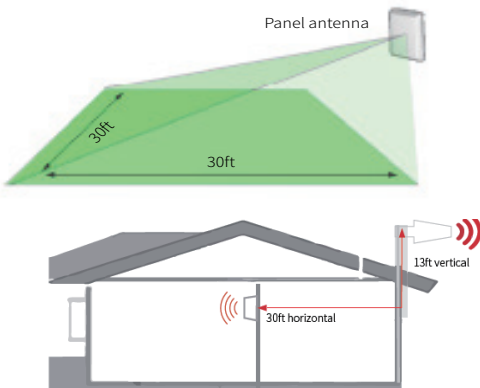

Have your indoor antenna pointed to the area you would like to cover with signal.

Notes:

- (1) It would be best if you could make the two antennas face opposite directions.
- (2) Make sure that the gain reaches about 60dB. If not, please adjust the direction of the indoor antenna/increase the vertical and horizontal distance between the two antennas/add some barriers.

Step 8 Signal quality test

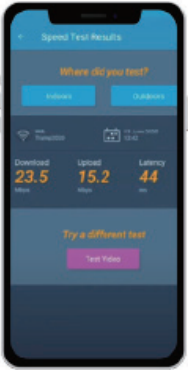

You could do the following:

- (1) First make sure the signal gauge value is unchanged from that during the outdoor antenna installation.
- (2) Do speed tests with the booster on and off, and make a comparison.
- (3) Check if the number of signal bars increases.
- (4) Make a phone call or send messages and check if the voice and streaming are better.

Step 9 Fix the Inside Antenna and the Booster

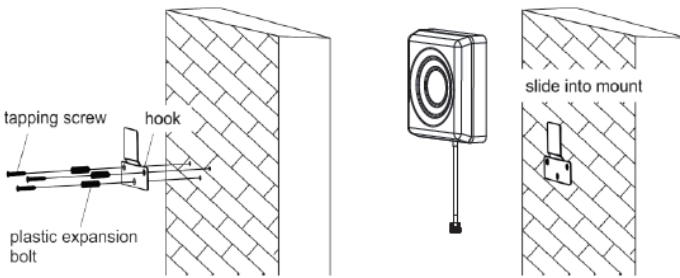

Fix the indoor antenna with the provided expansion bolt and hook.

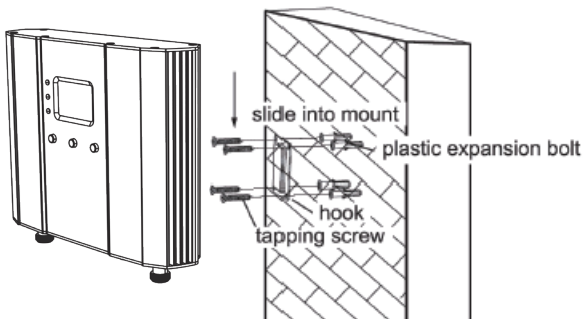

Fix the booster with the provided expansion bolt and hook.

4 Regular Problems and 1 normal status

If the booster is working normally, no further adjustment is required

OVERLOAD					
	DL GAIN	OUTPUT POWER	LED LIGHT PATTERN	REASON	SOLUTION
LTE700	<60dB	>=10dBm	Alarm light quick blinking green or red	Outdoor signal is too strong	Have your outdoor antenna pointed slightly away from the cell tower
CELL800	<60dB	>=10dBm			
PCS1900	<60dB	>=10dBm			
AWS2100	<60dB	>=10dBm			

LOOP BACK					
	DL GAIN	OUTPUT POWER	LED LIGHT PATTERN	REASON	SOLUTION
LTE700	<60dB	<10dBm	ISO light blinking green or red	Inadequate separation of the indoor and outdoor antennas	1. Increase vertical and horizontal distance. 2. Make the indoor and outdoor antennas face opposite directions. 3. Add barriers(e.g. walls) Please try these solutions until the gain reaches or is over 60dB.
CELL800	<60dB	<10dBm			
PCS1900	<60dB	<10dBm			
AWS2100	<60dB	<10 dBm			

POOR SIGNAL					
	DL GAIN	OUTPUT POWER	LED LIGHT PATTERN	REASON	SOLUTION
LTE700	>=60dB	--/NEGATIVE	Alarm light and ISO light solid green	Input signal is too weak	1. Try adjusting the outdoor antenna to the best direction 2. Try adjusting the outdoor antenna to another cell tower 3. Try increasing the height of the outdoor antenna and make sure there are no barriers between the tower and the outdoor antenna Please try these solutions until the output power reaches or is over -5dBm.
CELL800	>=60dB	--/NEGATIVE			
PCS1900	>=60dB	--/NEGATIVE			
AWS2100	>=60dB	--/NEGATIVE			

Normal but No Boosted Signal					
	DL GAIN	OUTPUT POWER	LED LIGHT PATTERN	REASON	SOLUTION
LTE700	>=60dB	>=-5dBm	Alarm light and ISO light solid green	1. The band is not supported 2. The Signal is from Other Carriers	Check the band you are using again. If it stays at band66, get into the 'Detail/' 'Setting' of gagues on Signal Supervisor and switch off RF switch of AWS2100, then adjust the outdoor antenna again. It would be better if there are two persons and one can stay near the indoor antenna to check if the signal is boosted.
CELL800	>=60dB	>=-5dBm			
PCS1900	>=60dB	>=-5dBm			
AWS2100	>=60dB	>=-5dBm			

NORMAL					
	DL GAIN	OUTPUT POWER	LED LIGHT PATTERN	REASON	SOLUTION
LTE700	>=60dB	>=-5dBm	Alarm light and ISO light solid green		
CELL800	>=60dB	>=-5dBm			
PCS1900	>=60dB	>=-5dBm			
AWS2100	>=60dB	>=-5dBm			

Note:

Some customers have some misunderstandings about boosters, and we would like to clarify it here:

If you can't even get a stable 1 bar outside the house or on the roof, then we suggest you return it as it won't work in areas with very weak signal, the same is true of all boosters on the market.

Technical Specifications

Model No.	4K Smart Link	10K Smart Link	15K Smart Link
Working Bands	Band 12/17/Band 13/Band 5/Band 25/2/Band 4		
UL Frequency Range	698-716 / 776-787 / 824-849 / 1850-1915 / 1710-1755		
DL Frequency Range	728-746 / 746-757 / 869-894 / 1930-1995 / 2110-2155		
Maximum Gain	60 dB	65 dB	72 dB
Maximum Output Power	UL 24 dBm, DL 10 dBm	UL 24 dBm, DL 12 dBm	
I/O Port	N-Female & SMA-Female		
Weight	> 4.0 lb / 1.8 kg	> 5.0 lb / 2.2 kg	
Dimensions	4.7in x 7.8in x1.4in / 120mm x 198mm x 34mm	8.6in x 6.5in x 2in / 218mm x 165mm x 50mm	
MGC(Step Attenuation)	>25 dB / 1 dB Step		
Impedance	50 ohm		
Environment Condition	IP40		
Power Supply	Input AC 100~240V, 50/60Hz, Output DC 12 V/3 A		



For more information

Download Signal Supervisor or enter our website.



www.hiboost.com

- a. You can download the specific user manual.
- b. You can reach our technical support for help.

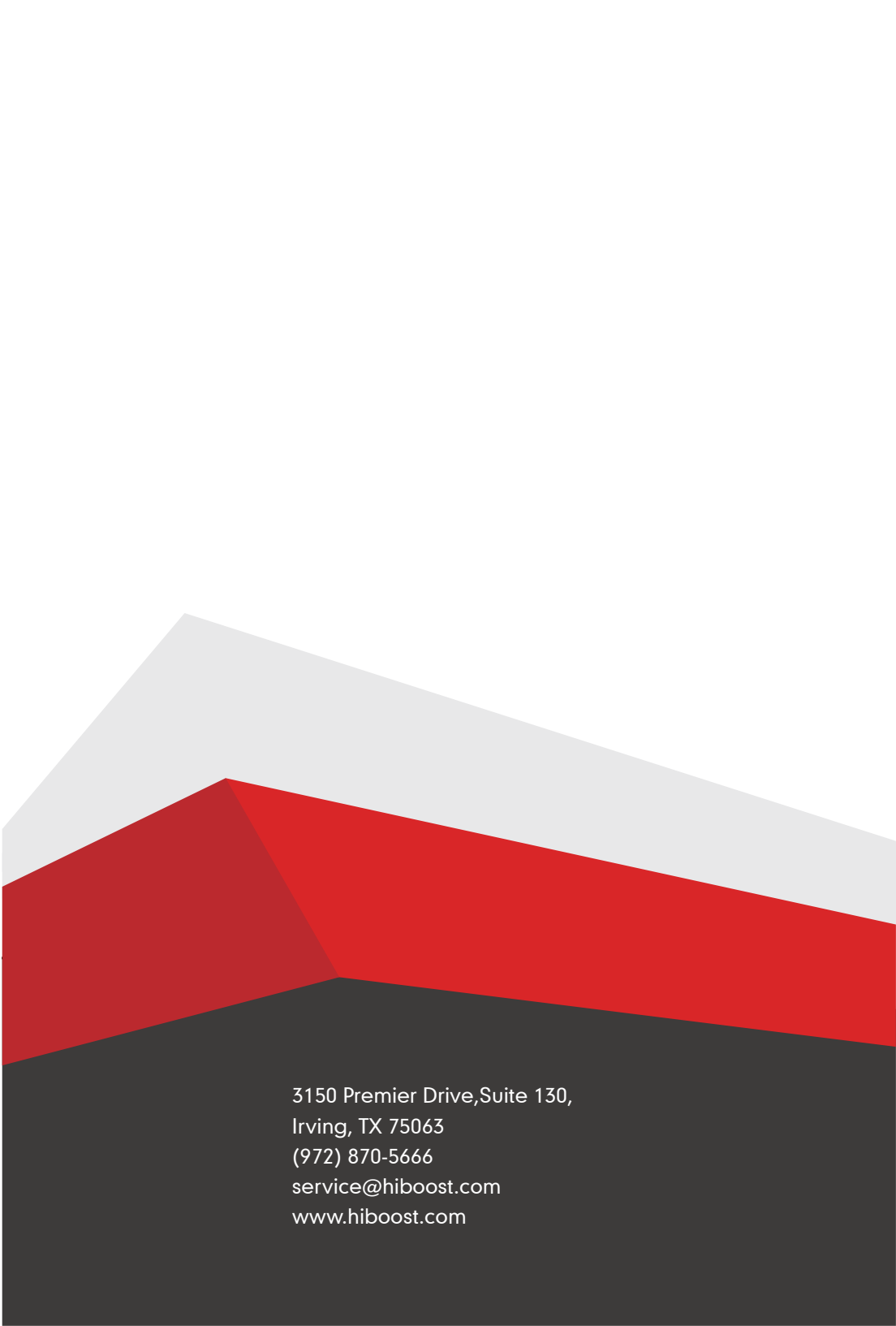

3150 Premier Drive, Suite 130,
Irving, TX 75063
(972) 870-5666
service@hiboost.com
www.hiboost.com